greenworks®

24V 8" POLESAW
PS24B00



Owner's Manual

TOLL-FREE HELPLINE: 1-888-90WORKS (888.909.6757)

www.greenworkstools.com

 Read all safety rules and instructions carefully before operating this tool.

CONTENTS

Contents	2
Product Specifications	2
Safety Rules	3
Symbols	6
Know Your Polesaw	7
Assembly	8
Operation	10
Maintenance.....	16
Environmentally Safe Battery Disposal.....	22
Troubleshooting.....	23
Warranty.....	24
Exploded View	25
Part List	26

PRODUCT SPECIFICATIONS

24V 8" POLESAW

Type	Cordless
Voltage	24V
Bar Length	8" (203mm)
Chain Pitch	3/8" LP (9.5 mm)
Chain Gauge.....	.050" (1.27 mm)
Chain Type.....	CL15033X
Bar Type.....	M1500833-1318
Oil Tank Capacity.....	60ml
Unit Weight (Without Battery).....	9.9 lbs (4.5 kg)



SAFETY RULES

Save all warnings and instructions for future reference.

The term “power tool” in all of the warnings listed below refers to your mains-operated (corded) power tool or battery-operated (cordless) power tool.

GENERAL SAFETY RULES

- Avoid Dangerous Environment – Don't use appliances in damp or wet locations.
- Don't Use In Rain.
- Keep Children Away – All visitors should be kept at a distance from work area.
- Dress Properly – Do not wear loose clothing or jewelry. They can be caught in moving parts. Use of rubber gloves and substantial footwear is recommended when working outdoors. Wear protective hair covering to contain long hair.
- Use Safety Glasses – Always use face or dust mask if operation is dusty.
- Use Right Appliance – Do not use appliance for any job except that for which it is intended.
- Don't grasp the exposed cutting blades or cutting edges when picking up or holding the appliance. (For grass shears and similar appliances only.)
- Don't Force Appliance – It will do the job better and with less likelihood of a risk of injury at the rate for which it was designed.
- Don't Overreach – Keep proper footing and balance at all times.
- Stay Alert – Watch what you are doing. Use common sense. Do not operate appliance when you are tired.
- Disconnect Appliance – Disconnect the appliance from the power supply when not in use, before servicing, when changing accessories such as blades, and the like.
- Store Idle Appliances Indoors – When not in use, appliances should be stored indoors in dry, and high or locked-up place – out of reach of children.
- Maintain Appliance With Care – Keep cutting edge sharp and clean for best performance and to reduce the risk of injury. Follow instructions for lubricating and changing accessories. Inspect appliance cord periodically, and if damaged, have it repaired by an authorized service facility. Inspect extension cords periodically and replace if damaged. Keep handles dry, clean, and free from oil and grease.
- Check Damaged Parts – Before further use of the appliance, a guard or other part that is damaged should be carefully checked to determine that it will operate properly and perform its intended function. Check for alignment of moving parts, binding of moving parts, breakage of parts, mounting, and any other condition that may affect its operation. A guard or other part that is damaged should be properly repaired or replaced by an authorized service center unless indicated elsewhere in this manual.

POLE SAW SAFETY RULES

- Keep all parts of the body away from the saw chain. Do not remove cut material or hold material to be cut when blades are moving. Make sure the switch is off when clearing jammed material. Saw chain continues to move after the switch is turned off. A moment of inattention while operating the pole saw may result in serious personal injury.
- Carry the pole saw by the handle with the saw chain stopped. When transporting or storing the pole saw, always fit the saw chain device cover. Proper handling of the pole saw will reduce possible personal injury from the saw chain.

SAFETY RULES

- Hold the pole saw by insulated gripping surfaces only, because the saw chain may contact hidden wiring or its own cord. A saw chain contacting a "live" wire may make exposed metal parts of the pole saw "live" and could give the operator an electric shock.
- Keep cable away from cutting area. During operation the cable may be hidden in shrubs and can be accidentally cut by the saw chain.
- Do not use the pole saw in bad weather conditions, especially when there is a risk of lightning. This decreases the risk of being struck by lightning.
- To reduce the risk of electrocution, never use near any electrical power lines. Contact with or use near power lines may cause serious injury or electric shock resulting in death.
- Always use two hands when operating the pole saw. Hold the pole saw with both hands to avoid loss of control.
- Always use head protection when operating the pole saw overhead. Falling debris can result in serious personal injury.
- Always remove battery pack from your tool when you are assembling parts, making adjustments, cleaning, or when not in use. Removing battery pack will prevent accidental starting that could cause serious personal injury.

⚠ CAUTION

When using an cordless pole saw, basic safety precaution should always be followed to reduce the risk of fire, electric shock, and injury to persons.

⚠ WARNING (PROPOSITION 65)

This product contains a chemical known to the state of California to cause cancer, birth defects or other reproductive harm.

Some dust created by power sanding, sawing, grinding, drilling and other construction activities contains chemicals known to cause cancer, birth defects or other reproductive harm. Some examples of these chemicals are:

- Lead from lead-based paints,
- Crystalline silica from bricks and cement and other masonry products, and
- Arsenic and chromium from chemically-treated lumber.

Your risk of exposure to these chemicals varies depending on how often you do this type of work. To reduce your exposure to these chemicals, work in a well-ventilated area, and work with approved safety equipment, such as dust masks that are specially designed to filter out microscopic particles.













CHILD SAFETY

Tragic accidents can occur if the operator is not aware of the presence of children.

- Keep children out of the working area and under the watchful care of a responsible adult.
- Do not allow children under the age of 14 to operate this pole saw. Children who are 14 years of age and older must read and understand the operating instructions and safety rules in this manual and must be trained and supervised by a parent.
- Stay alert, and turn the pole saw off if a child or any other person enters the working area.
- Use extreme care when approaching blind corners, doorways, shrubs, trees, or other objects that may obscure your view of a child who may run into the wrong area.



SYMBOLS

Some of the following symbols may be used on this product. Please study them and learn their meaning. Proper interpretation of these symbols will allow you to operate the product better and safer.

SYMBOLS	DESIGNATION	EXPLANATION
V	Volts	Voltage
A	Amperes	Current
Hz	Hertz	Frequency (cycles per second)
W	Watts	Power
hrs	Hours	Time
n_0	No Load Speed	Rotational speed, at no load
/min	Per Minute	Revolutions, strokes, surface speed, orbits etc., per minute
	Eye and Head Protection	Wear eye and head protection when operating this equipment.
	Safety Alert Symbol	Precautions that involve your safety
	Read the Instruction Manual	To reduce the risk of injury, user must read and understand the Instruction manual before using this product
	Eye Protection	Wear eye protection when operating this equipment
	Hearing Protection	Wear hearing protection when operating this equipment
	Gloves	Wear non-slip, heavy-duty protective gloves when handling the polesaw and the blade
	Safety Footwear	Wear non-slip safety footwear when using this equipment
	Kickback	DANGER! Beware of kickback
	Operate With Two Hands	Hold and operate the saw properly with both hands
	One Handed	Do not operate the saw using only one hand
	Risk of Electrocution	DANGER! Risk of electrocution!
	Keep Bystanders Away	Keep all bystanders at least 50' (15 m) away
	Wet Conditions Alert	Do not expose to rain or use in damp locations.

SYMBOLS

The following signal words and meanings are intended to explain the levels of risk associated with this product.

SYMBOL	SIGNAL	MEANING
	DANGER	Indicates an imminently hazardous situation, which, if not avoided, will result in death or serious injury.
	WARNING	Indicates a potentially hazardous situation, which, if not avoided, could result in death or serious injury.
	CAUTION	Indicates a potentially hazardous situation, which, if not avoided, may result in minor or moderate injury.
	CAUTION	(Without Safety Alert Symbol) Indicates a situation that may result in property damage.

SERVICE

Servicing requires extreme care and knowledge and should be performed only by a qualified service technician. For service we suggest you return the product to your nearest **AUTHORIZED SERVICE CENTER** for repair. When servicing, use only identical replacement parts.

WARNING

To avoid serious personal injury, do not attempt to use this product until you have read this Owner's Manual thoroughly and understand it completely. If you do not understand the warnings and instructions in this Owner's Manual, do not use this product. Call the Toll-free Helpline (1-888-909-6757) for assistance.



The operation of any power tool can result in foreign objects being thrown into your eyes, which can result in severe eye damage. Before operating a power tool, always wear safety goggles, safety glasses with side shields, or a full face shield when needed. We recommend a Wide Vision Safety Mask for use over eyeglasses or standard safety glasses with side shields. Always use eye protection that is marked to comply with ANSI Z87.1.

SAVE THESE INSTRUCTIONS

KNOW YOUR POLESAW

Read this operator's manual and safety rules before operating your polesaw. Compare the illustration in (Figure 1) to your polesaw in order to familiarize yourself with the location of various controls and adjustments. Save this manual for future reference.

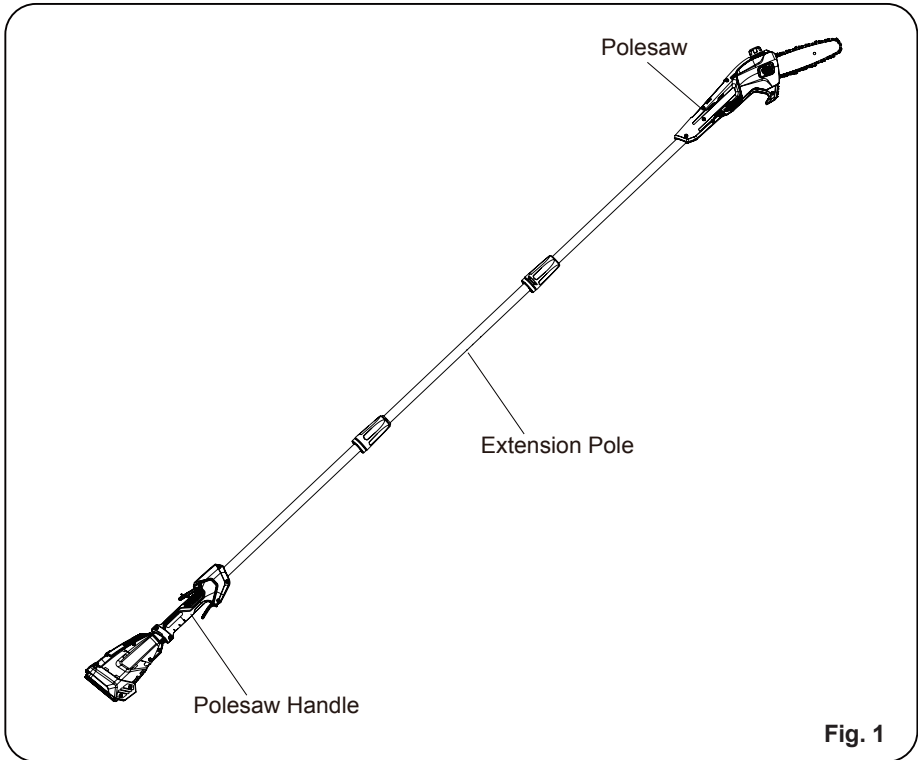

Fig. 1



ASSEMBLY INSTRUCTION

UNPACKING

This product requires assembly.

- Carefully remove the product and any accessories from the box. Make sure that all items listed in the package contents section are included.
- Inspect the product carefully to make sure no breakage or damage occurred during shipping.
- Do not discard the packing material until you have carefully inspected and satisfactorily operated the product.
- If any parts are damaged or missing, please call 1-888-909-6757 for assistance.

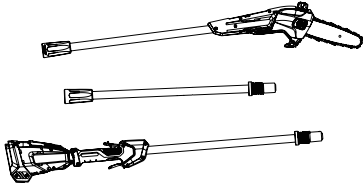
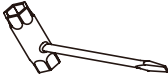
PACKING LIST

Part Name	Figure	Qty
Polesaw		1
Wrench		1
Operator's Manual		1

▲ W A R N I N G

If any parts are damaged or missing, do not operate this product until the parts are replaced. Failure to heed this warning could result in serious personal injury.

▲ W A R N I N G

Do not insert battery until assembly is complete. Failure to comply could result in accidental starting and possible serious personal injury.

ASSEMBLY INSTRUCTION

▲ WARNING

Do not allow familiarity with this product to make you careless. Remember that a careless fraction of a second is sufficient to inflict serious injury.

▲ WARNING

Always wear safety goggles or safety glasses with side shields when operating power tools. Failure to do so could result in objects being thrown into your eyes, resulting in possible serious injury.

▲ WARNING

Do not use any attachments or accessories not recommended by the manufacturer of this product. The use of attachments or accessories not recommended can result in serious personal injury.

FITTING THE POLE SAW (See Figure 2)

Before using the pole saw, assembly is required. When removed from the box, there are the three poles as shown below.

- The saw head can be mounted directly on polesaw handle to achieve the standard length.
- Insert the polesaw handle in the saw head.
- Slide the collar upwards and turn it clockwise until it is completely tightened.

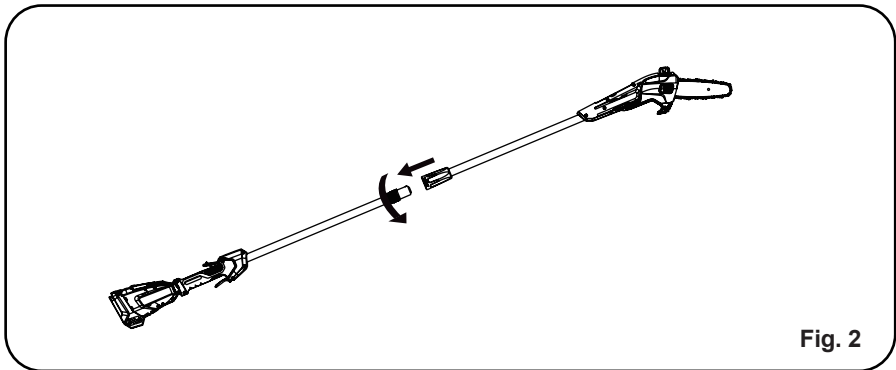

Fig. 2

EXTENSION OF POLE SAW (See Figure 3)

The maximum reach can be achieved by fitting the extension pole between the polesaw handle and the saw head.

- Slide the collars up and rotate it clockwise until it is completely tightened.

ASSEMBLY INSTRUCTION

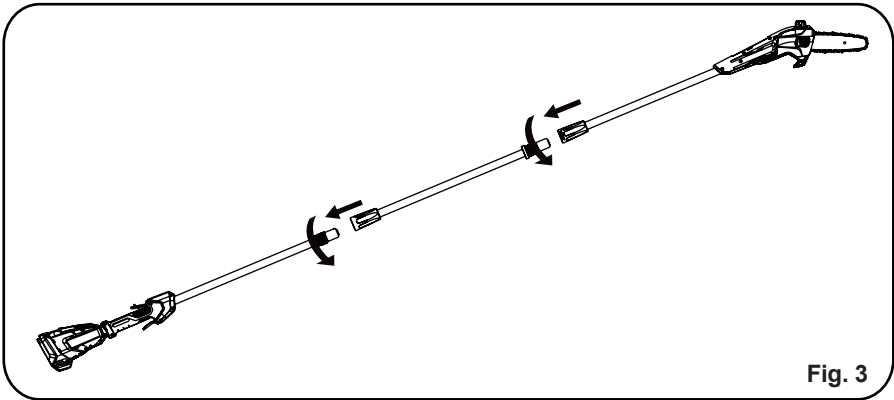

Fig. 3

REMOVING THE SAW HEAD (See Figure 4)

- Rest the pole saw on the ground, loosen the coupler, then take off the saw head.

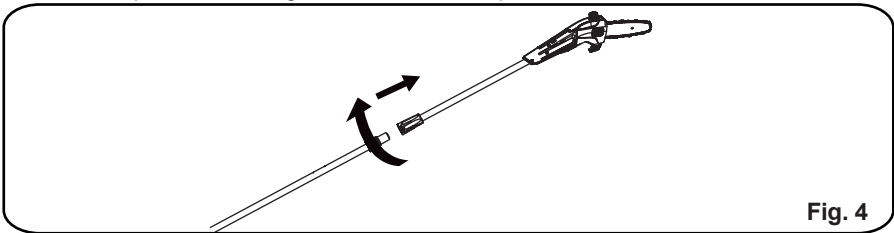

Fig. 4

APPLICATIONS

You may use this product for the purposes listed below:

- Limbing
- Pruning

OPERATION

ADDING BAR AND CHAIN LUBRICANT (See Figure 5)

Use Bar and Chain Lubricant. It is designed for chains and chain oilers, and is formulated to perform over a wide temperature range with no dilution required.

NOTE: Polesaw comes from the factory with no bar and chain oil added. Level should also be checked after every 30 minutes of use and refilled as needed.

- Remove oil cap.
- Carefully pour the bar and chain oil into the tank.
- Wipe off excess oil.
- Check and fill the oil tank when there is no oil in the oil tank.
- Repeat as needed.

NOTE: Do not use dirty, used or otherwise contaminated oils. Damage may occur to the bar or chain.

NOTE: It is normal for oil to seep from the saw when not in use. To prevent seepage, empty the oil tank after each use then run for one minute. When storing the unit for a long period of time (three months or longer) be sure the chain is lightly lubricated; this will prevent rust on the chain and bar sprocket.

▲ I M P O R T A N T

To preserve natural resources, please recycle or dispose of oil properly. Consult your local waste authority for information regarding available recycling and/disposal options.

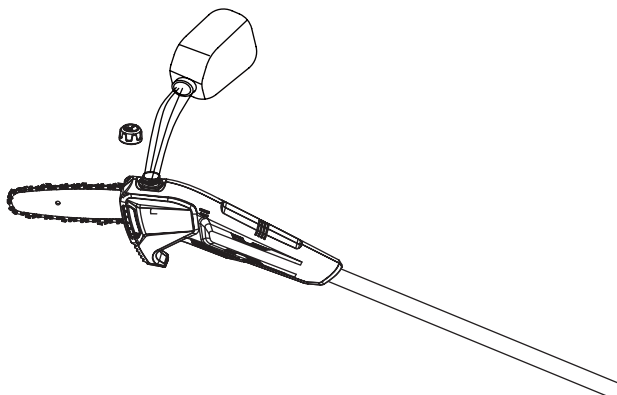

Fig. 5

OPERATION

BATTERY PACK (See Figure 6)

▲ I M P O R T A N T

The battery pack is not charged when it is purchased. Before using the polesaw for the first time, place the battery pack in the battery charger and charge it fully. Be sure to read all safety precautions, and follow the instructions in the section entitled Charging Procedure. With regular use, the battery will require shorter charging times. When storing the polesaw for a prolonged period of time, remove the battery. When the polesaw is going to be used again, charge the battery pack for at least a full charging period. This product has no memory effect.

REMOVING THE BATTERY PACK

- Press the latch button on the battery pack down and hold.
 - Grasp the polesaw firmly, and pull the battery pack out of the handle.
-

NOTE: The battery pack fits into the handle snugly in order to prevent accidental dislodging. It may require a strong pull to remove it.

INSTALLING THE BATTERY PACK

- Align the tongue of the battery pack with the cavity.
- Grasp the polesaw firmly.
- Push the battery pack into the handle until the latch locks into place. It should slide into position and “click”.

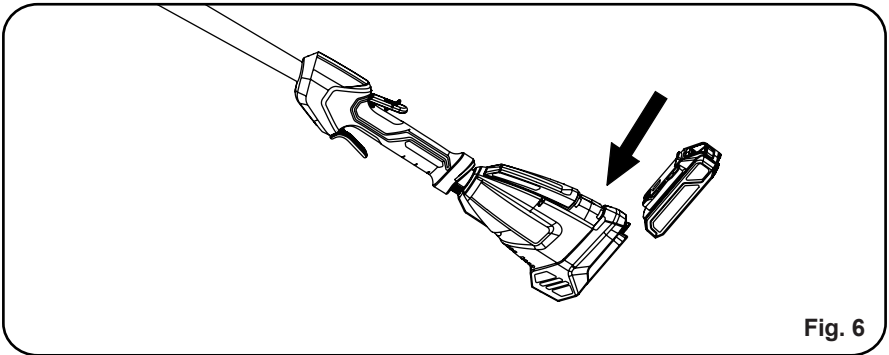

▲ W A R N I N G

Follow these instructions in order to avoid injury and to reduce the risk of electric shock or fire:

- Replace the battery pack or the charger immediately if the battery case or charger cord is damaged.
 - Verify that the switch is in the OFF position before inserting or removing the battery pack.
 - Verify that the battery pack is removed and the switch is in the OFF position before inspecting, adjusting, or performing maintenance on any part of the polesaw.
 - Read, understand, and follow the instructions contained in the section entitled Charging Procedure.
-

OPERATION

⚠ IMPORTANT

This Lithium-ion battery pack is equipped with an internal circuit breaker which will automatically shut off the power to the tool and then reset itself once cooled.

Follow these steps if an overload occurs while under heavy use:

1. Release the power switch and restart tool by depressing switch.
 2. The battery may need to be removed for approximately 1 minute, allowed to cool and then reinstalled for use.
-

STARTING AND STOPPING (See Figure 7)

TO START THE MOTOR:

- Fit the battery pack into the polesaw.
- Pull the small safety lock button upward using your thumb.
- Squeeze the safety lock button.
- Squeeze the trigger.

TO STOP THE MOTOR:

- Release the trigger.

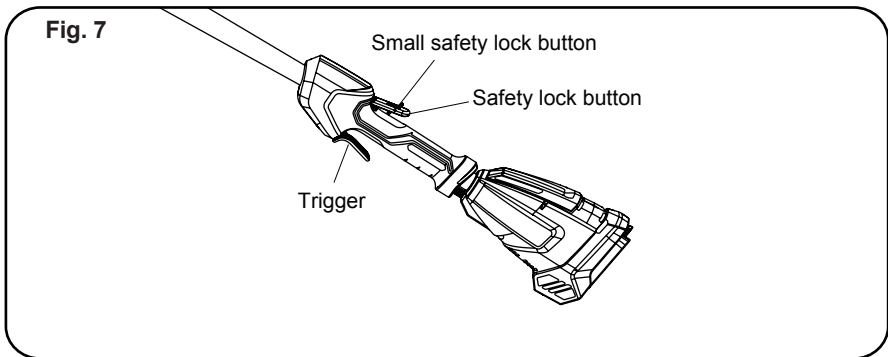

OPERATION

PREPARATION FOR CUTTING

- Wear non-slip gloves for maximum grip and protection.
- Maintain a proper grip on the unit whenever the motor is running. Use your right hand to firmly grip the rear handle while your left hand has a firm grip on the pole shaft.
- Hold unit firmly with both hands. Always keep your left hand on the pole shaft and your right hand on the rear handle, so your body is to the left of the chain line. Never use a left-handed (cross-handed) grip, or any stance that places your body or arm across the chain line.
- Never stand directly under the limb you are cutting.
- Be certain the collars are fully tightened before operating equipment; check them periodically for tightness during use to avoid serious injury.

BASIC CUTTING PROCEDURE

Follow the steps below to prevent damage to tree or shrub bark. Do not use a back-and-forth sawing motion.

- Make a shallow first cut (1/4 of limb diameter) on the underside of the limb close to the main limb or trunk.
- Make a second cut from the top side of the limb outboard from the first cut. Continue the cut through the limb until the limb separates from the tree. Be prepared to balance the weight of the tool when the limb falls.
- Make a final cut close to trunk.

NOTE: For second and final cuts (from top of limb or branch), hold front cutting guide against the limb being cut. This will help steady the limb and make it easier to cut. Allow chain to cut for you; exert only light down-ward pressure. If you force the cut, damage to the bar, chain, or motor can result.

- Release the trigger as soon as the cut is completed. Failure to follow proper cutting procedures will result in the bar and chain binding and becoming pinched or trapped in the limb. If this should happen:
- Stop the motor and remove the battery from the polesaw.
- If the limb can be reached from the ground, lift the limb while holding the saw. This should release the "pinch" and free the saw.
- If the saw is still trapped, call a professional for assistance.

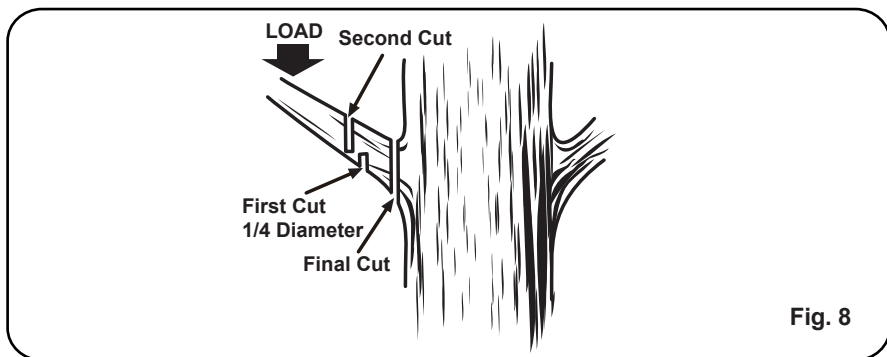

Fig. 8

OPERATION

LIMBING AND PRUNING(See Figure 8-9)

This unit is designed for trimming small branches and limbs up to 6 in. (15.2 cm) in diameter. For best results, observe the following precautions:

- Plan the cut carefully. Be aware of the direction in which the branch will fall.
- Branches may fall in unexpected directions. Do not stand directly under the branch being cut.
- The most typical cutting application is to position the unit at an angle of 60° or less, depending on the specific situation. As the angle of the polesaw shaft to ground increases the difficulty of making the first cut (from underside of limb) increases.
- Remove long branches in several stages.
- Cut lower branches first to allow the top branches more room to fall.
- Work slowly, keeping both hands on the saw with a firm grip. Maintain secure footing and balance.
- Keep the tree between you and the chain while limbing. Cut from the side of the tree opposite of the branch you are cutting.
- Do not cut from a ladder; this is extremely dangerous. Leave this operation for professionals.
- Do not make the flush cut next to the main limb or trunk until you have cut off the limb further out to reduce the weight.
- Following proper cutting procedures will prevent stripping the bark from the main member.
- Do not use the polesaw for felling or bucking.
- To prevent electrocution, do not operate within 50 ft. (15 m) of overhead electrical lines.
- Keep bystanders at least 50 ft. (15 m) away.

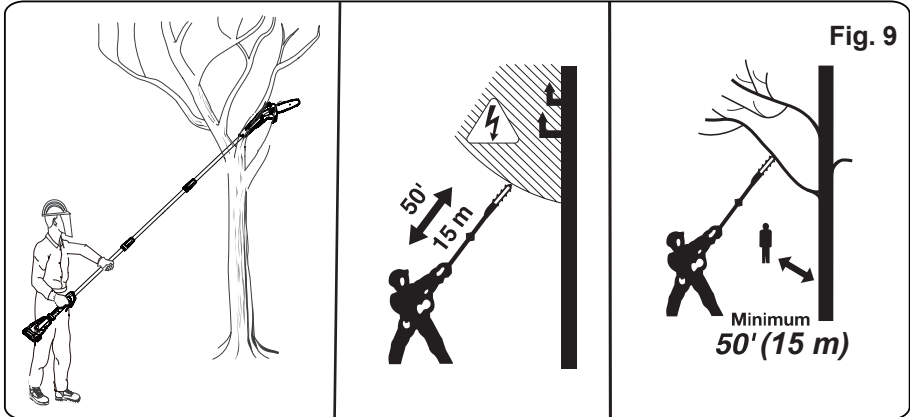

MAINTENANCE

⚠ WARNING

When servicing, use only identical replacement parts. Use of any other parts may create a hazard or cause product damage.

⚠ WARNING

Always wear safety goggles or safety glasses with side shields during power tool operation or when blowing dust. If operation is dusty, also wear a dust mask.

⚠ WARNING

Before inspecting, cleaning or servicing the unit, stop the motor, wait for all moving parts to stop, and remove the battery. Failure to follow these instructions can result in serious personal injury or property damage.

GENERAL MAINTENANCE

Avoid using solvents when cleaning plastic parts. Most plastics are susceptible to damage from various types of commercial solvents and may be damaged by their use. Use clean cloths to remove dirt, dust, oil, grease, etc.

⚠ WARNING

Do not at any time let brake fluids, gasoline, petroleum-based products, penetrating oils, etc., come in contact with plastic parts. Chemicals can damage, weaken, or destroy plastic, which may result in serious personal injury.

All polesaw service, other than the items listed in the instruction manual maintenance instructions, should be performed by competent polesaw service personnel. (For example, if improper tool is used to hold the flywheel in order to remove the clutch, structural damage to the flywheel could occur and subsequently could cause the flywheel to burst).

MAINTENANCE

ADJUSTING CHAIN TENSION (See figure 10)

Always switch off the machine and remove the battery before checking or adjusting chain tension. Wear protective gloves while handling the chain, bar or areas around the chain.

1. Untighten the side cover lock nuts (1) slightly by turning them counterclockwise. You do not need to remove the side cover (2) in order to adjust the chain tension.
2. To increase the chain tension, turn the chain tensioner adjustment screw (3) clockwise and check the chain tension frequently. To reduce the chain tension, turn the chain tensioner adjustment screw (3) counterclockwise and check the chain tension frequently.
3. Pull the chain in the middle of the lower side of the bar downwards (away from the bar) and measure the distance between the bar and the chain. The chain tension is correct when the gap between the cutter in the chain and the bar is between 3mm-4mm.
4. When chain tension is set correctly, retighten the side cover lock nuts (1).

NOTE: During normal saw operation, the temperature of the chain increases. The drive links of a correctly tensioned warm chain will hang approximately 1/16 in. (1,58 mm) out of the bar groove.

NOTE: New chains tend to stretch; check the chain tension frequently and tension as required.

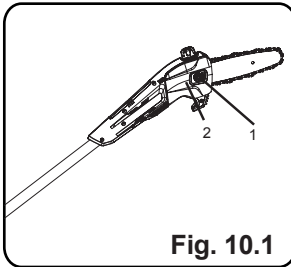

Fig. 10.1

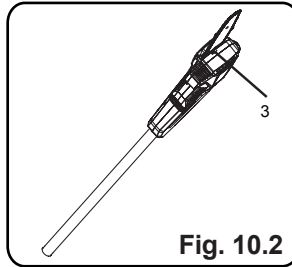

Fig. 10.2

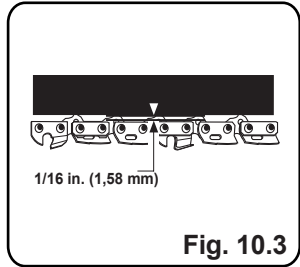

Fig. 10.3

BAR AND CHAIN REPLACEMENT (See figure 11)

The user should know how to assemble the guide bar and chain. Check the chain tensioning and add oil as described in this manual before each operation.

1. Remove the battery from the unit. Wear protective gloves.
2. Unscrew the side cover lock nuts.
3. Remove the side cover.

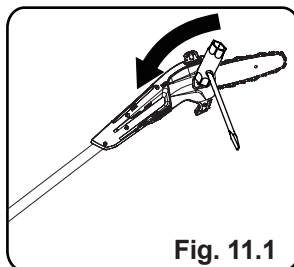

Fig. 11.1

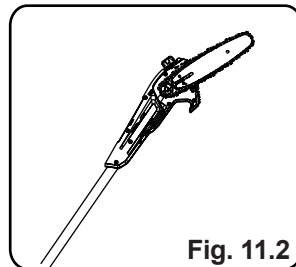
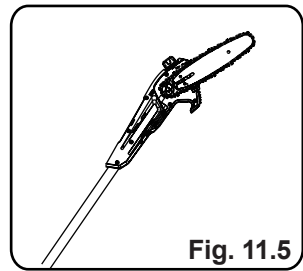
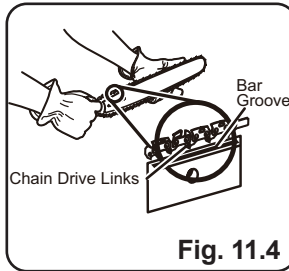
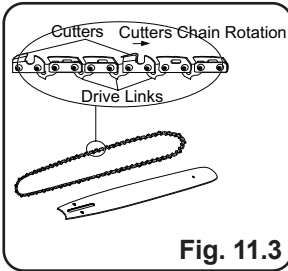

Fig. 11.2

4. The chain should face in the direction of chain rotation. If they face backwards, turn the loop over.

MAINTENANCE

5. Hold the chain in position on the bar and place the loop around the sprocket and make sure it is correctly mounted. Make sure the bar hole fits well with bolt for chain tension.



6. Replace the side cover, turn the chain tension adjustment screw clockwise until the chain is properly tensioned. The guide bar must then be pushed upwards and check chain tension again. Do not tension the chain too tight.

7. After the chain is well-tensioned, tighten the nut again.

8. Once the chain is well tensioned, tighten the side cover lock nuts. Start with a new chain, allowing it to run-in for 2-3 minutes.

NOTE: If the chain is too tight, it will not rotate. Loosen the chain cover lock nuts slightly and turn the chain adjustment screw 1/4 turn counterclockwise. Lift the tip of the guide bar up and retighten the chain cover lock nuts. Ensure that the chain will rotate without binding.

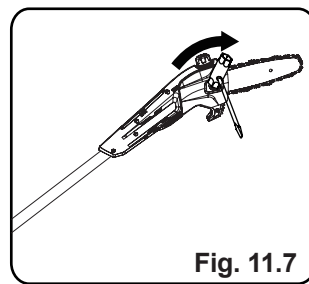
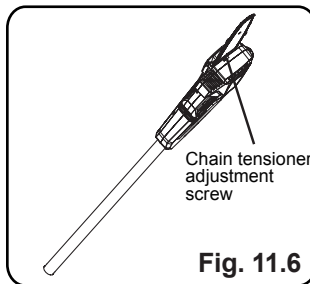

MAINTENANCE

CHAIN OILER

- Use a lubricant that is designed for chains and chain oilers and is formulated to perform over a wide temperature range with no dilution required.
- Remove the cap and carefully pour approximately 2 oz (57 g) of bar and chain lubricant into the bar lube reservoir.
- Replace the cap and tighten securely.
- Check and refill the bar lube reservoir every time the polesaw is used.

NOTE: *If chain is too tight, it will not rotate. Loosen the bar cover knob slightly and turn adjusting screw 1/4 turn counterclockwise. Lift the tip of the bar up and retighten bar cover knob.*

NOTE: *Do not use dirty, used, or otherwise contaminated lubricants. Damage may occur to the oil pump, bar, or chain.*

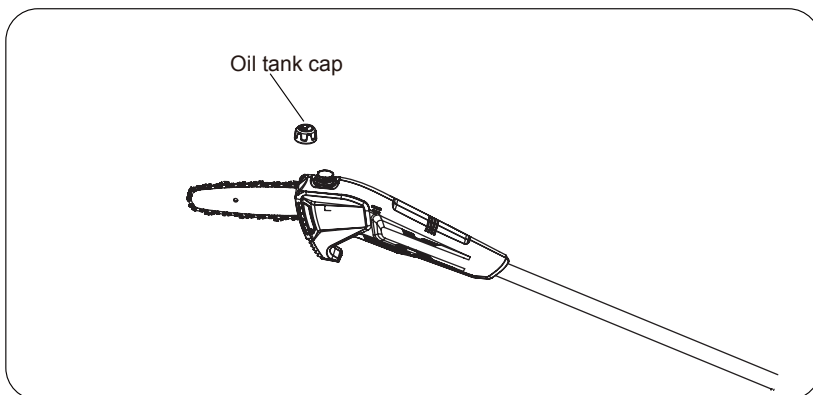

MAINTENANCE

CHAIN MAINTENANCE

For smooth and fast cutting, the chain needs to be maintained properly. The following conditions indicate that the chain requires sharpening:

- Wood chips are small and powdery.
- Chain must be forced through the wood during cutting.
- Chain cuts to one side.

During maintenance of the chain, consider the following:

- Improper filing angle of the side plate can increase the risk of a severe kickback.
- Depth gauge (or raker clearance) setting determines the height the cutter enters the wood and the size of the wood chip that is removed. Too much clearance increases the potential for kickback. Too little clearance decreases the size of the wood chip thus decreasing the chain's cutting ability.
- If cutter teeth have hit hard objects such as nails or stones, or have been abraded by mud or sand on the wood, have service dealer sharpen chain.

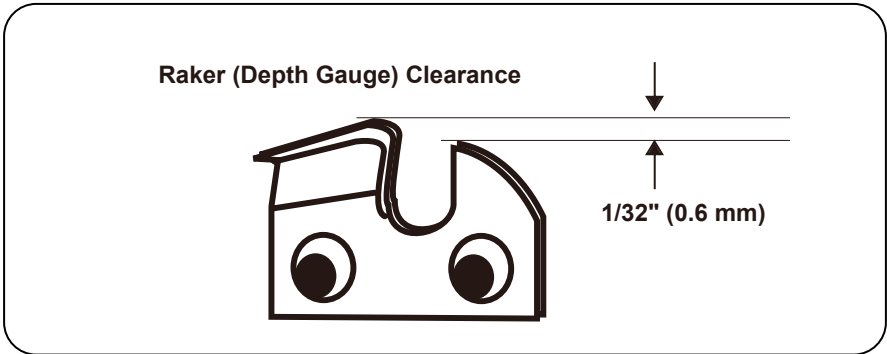

MAINTENANCE

HOW TO SHARPEN THE CUTTERS

Be careful to file all cutters to the specified angles and to the same length, as fast cutting can be obtained only when all cutters are uniform.

- Tighten the chain tension enough that the chain does not wobble. Do all of your filing at the midpoint of the bar. Wear gloves for protection.
- Use a round file and holder.
- Keep the file level with the top plate of the tooth. Do not let the file dip or rock.
- Using light but firm pressure, stroke towards the front corner of the tooth. Lift file away from the steel on each return stroke.
- Put a few firm strokes on every tooth. File all left hand cutters in one direction. Then move to the other side and file the right hand cutters in the opposite direction. Occasionally remove filings from the file with a wire brush.

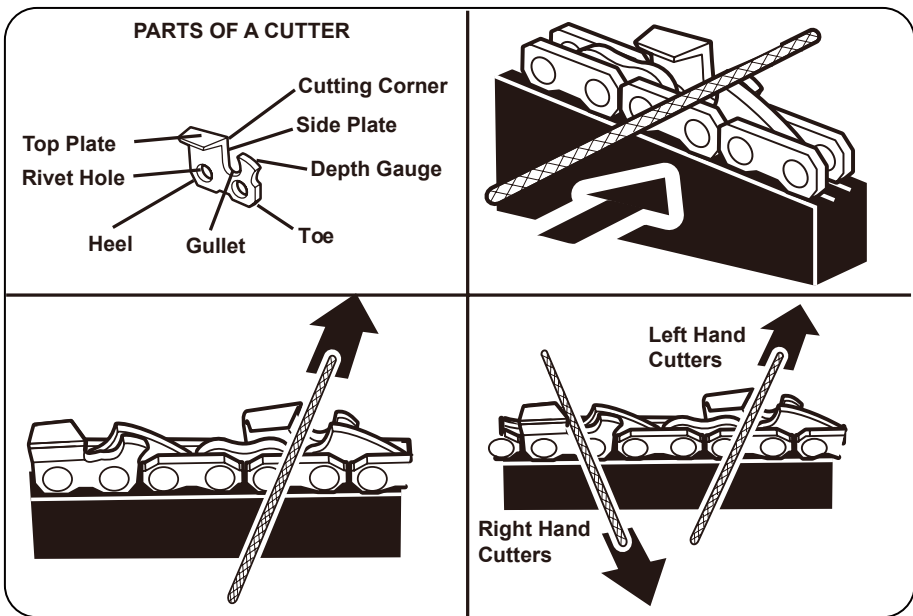

⚠ CAUTION

Dull or improperly sharpened chain can cause excessive motor speed during cutting which may result in severe motor damage.

⚠ WARNING

Improper chain sharpening increases the potential of kickback. Failure to replace or repair damaged chain can cause serious injury.

ENVIRONMENTALLY SAFE BATTERY DISPOSAL

The batteries used in this polesaw's battery pack contain the following toxic and corrosive material: LITHIUM-ION, a toxic material.



⚠ W A R N I N G

Toxic materials must be disposed of in a specific manner in order to prevent contamination of the environment. Before disposing of damaged or worn out Lithium-Ion battery packs, contact your local waste disposal agency or the local Environmental Protection Agency for information and specific instructions. Take the batteries to a local recycling and/or disposal center that is certified for disposal. If the battery pack cracks or breaks, whether it leaks or not, do not recharge it and do not use it. Dispose of it and replace it with a new battery pack.

DO NOT ATTEMPT TO REPAIR IT!

Follow these instructions and to avoid damage to the environment:

- Cover the battery's terminals with heavy-duty adhesive tape.
- Do not attempt to remove or destroy any of the components of the battery pack.
- Do not attempt to open the battery pack.
- If a leak develops, the electrolytes that are released are corrosive and toxic. Do not get the solution in the eyes or on the skin, and do not swallow it.
- Do not place batteries in regular household trash.
- DO NOT incinerate batteries.
- DO NOT place batteries where they will become part of any waste landfill or municipal solid waste stream.
- Dispose of batteries at a certified recycling or disposal center.

TROUBLESHOOTING

PROBLEM	POSSIBLE CAUSE	SOLUTION
Polesaw fails to turn on.	The poles are not assembled correctly.	Reassemble the poles according to the instructions.
	No electrical contact between the polesaw and battery.	To secure the battery, make sure the latches on the battery compartment snap into place.
	The battery pack is depleted.	Charge the battery pack.
	The lock-off lever and trigger are not depressed simultaneously.	Press down the lock-off lever and hold it, then depress the trigger to turn on the pole saw.
	The battery and power tool is too hot or too cold.	Refer to the battery and charger maintenance part in the manual.
Bar and chain running hot and smoking.	No oil in the oil tank.	Refill oil into the oil tank.
	The discharge port is blocked by debris.	Remove the bar according to the manual and then clean out the debris.
	Inlet opening in inner oil tank is blocked by debris.	Clean the oil tank, and refill with clean bar and chain lubricant.
	The sprocket is stuck and clogged with debris.	Clean the sprocket and refill with clean bar and chain lubricant.
The chain and bar running too hot and cannot cut.	Check chain tension for overtightened or loose condition.	Refer to Re-tensioning the saw chain in the manual.
	Dull chain.	Sharpen or replace the chain.
	Chain on backwards.	Refer to Replacing the Bar and Chain assembly earlier in this manual.
Motor running, but cutting abnormal.	Motor stops after about 3 seconds.	Recharge the battery.
	When using the polesaw under load, it stops.	Release trigger. Restart the polesaw. Do not force the polesaw. Refer to the manual for proper use.
	Battery is not charged.	Charge the battery. Refer to the battery and charger manual for correct charging procedures.
	Lack of bar and chain lubricant can cause increased friction. Chain needs to be properly maintained.	Make sure the polesaw always has bar and chain lubricant.
	Incorrect battery storage temperature.	Allow the battery pack to cool until the temperature drops to room temperature.

LIMITED WARRANTY



Greenworks® hereby warrants this product, to the original purchaser with **proof of purchase**, for a period of four (4) years against defects in materials, parts or workmanship. Greenworks®, at its own discretion will repair or replace any and all parts found to be defective, through normal use, free of charge to the customer. This warranty is valid only for units which have been used for personal use that have not been hired or rented for industrial/commercial use, and that have been maintained in accordance with the instructions in the owners' manual supplied with the product from new.

ITEMS NOT COVERED BY WARRANTY:

1. Any part that has become inoperative due to misuse, commercial use, abuse, neglect, accident, improper maintenance, or alteration; or
2. The unit, if it has not been operated and/or maintained in accordance with the owner's manual; or
3. Normal wear, except as noted below;
4. Routine maintenance items such as lubricants, blade sharpening;
5. Normal deterioration of the exterior finish due to use or exposure.

GREENWORKS® PRO HELPLINE:

Warranty service is available by calling our toll-free helpline at **1-888-909-6757**.

TRANSPORTATION CHARGES:

Transportation charges for the movement of any power equipment unit or attachment are the responsibility of the purchaser. It is the purchaser's responsibility to pay transportation charges for any part submitted for replacement under this warranty unless such return is requested in writing by Greenworks®.

EXPLODED VIEW

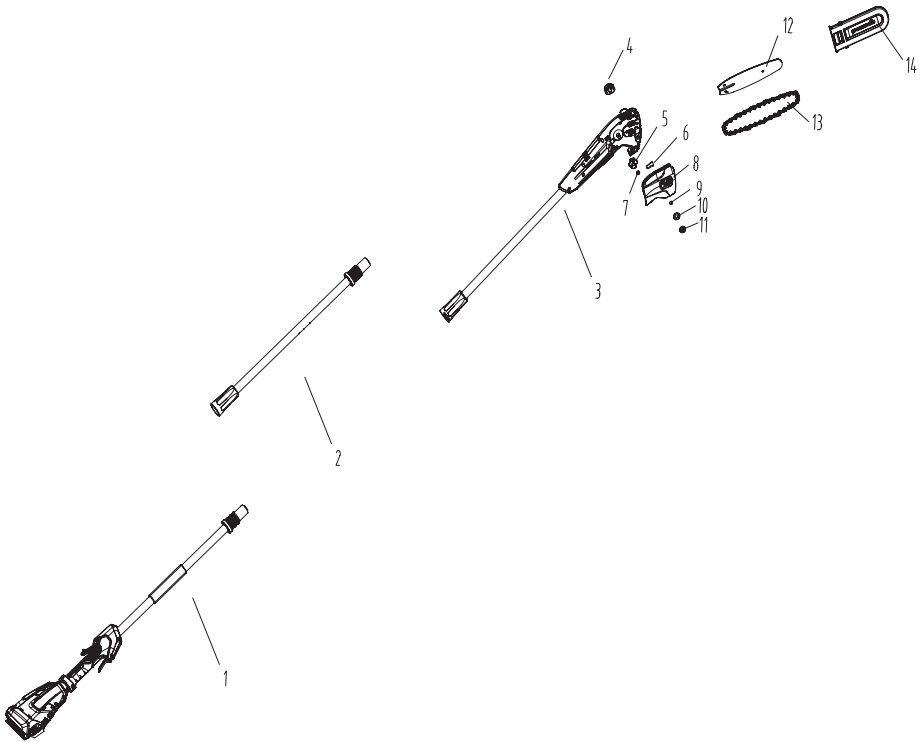

PARTS LIST

ITEM NO.	PART NO.	DESCRIPTION	QTY
1	311022706	Polesaw Handle Assembly	1
2	311032705	Pole Assembly	1
3	311012706	Polesaw Head Assembly	1
4	341071071B	Oil Tank Cap	1
5	33902102C	Sprocket	1
6	34288586A	Oil Seal Gasket	1
7	32209590	Clip	1
8	341032701B	Side Cover	1
9	329011898	Circular Traveler	1
10	332031898A	Bushing	1
11	332041898B	Lock Nut	1
12	32902320F	Bar	1
13	329012701	Chain	1
14	34112320-2	Scabbard	1

greenworks®

Greenworks Tools
P.O. Box 1238
Mooresville, NC28115

TOLL-FREE HELPLINE: 1-888-90WORKS (888.909.6757)

Rev: 00 (07-17-16)